



POWER AMPLIFIER

PT-X1000A

OWNER'S MANUAL

VESTAX CORP.

2-37-1 Kamiyama, Setagaya-ku, Tokyo 154-0011 Japan

Phone: 03-3412-7011 Fax: 03-3412-7013

VESTAX MUSICAL ELECTRONICS CORP.

2860 Cordelia Rd., Suite 120 Fairfield, CA 94585 U.S.A.

Phone: 707-427-1920 Fax: 707-427-2023



VESTAX (Europe) Ltd.

18 St. Christophers Road, Haslemere, Surrey GU 27 1DQ England.

Phone: (0)1428-653117 Fax: (0)1428-661021

FEATURES

1. This Stereo power amplifier is designed in England packed in a 1U size body. The secret of its high power is MOS-FET power element and Toroidal transformer. Consistently reproduces wide dynamic range and driving impression of original sound. Extraordinary sound pressure which is equivalent to the high class model. English know-how, which scrupulously pursues sound excellence in everything from the PCB pattern to each condenser, makes the high-quality sound possible.
2. Equipped with a cooling system which has a strong but quiet cooling fan for stable, continuous operation. Furthermore, a perfect protection system takes into consideration every possible trouble, such as overload or speaker short. This unit responds with the dependability and durability always demanded by professionals.

	CAUTION RISK OF ELECTRIC SHOCK DO NOT OPEN	
CAUTION : TO REDUCE THE RISK OF ELECTRIC SHOCK DO NOT REMOVE COVER (OR BACK) NO USER-SERVICEABLE PARTS INSIDE REFER SERVICING TO QUALIFIED SERVICE PERSONNEL		



The lightning flash with arrowhead symbol, within an equilateral triangle, is intended to alert the user to the presence of uninsulated "dangerous voltage" within the product's enclosure that may be of sufficient magnitude to constitute a risk of electric shock to persons.



The exclamation point within an equilateral triangle is intended to alert the user to the presence of important operating and maintenance (servicing) instructions in the literature accompanying the appliance.

WARNING

TO REDUCE THE RISK OF FIRE OR ELECTRIC SHOCK, DO NOT EXPOSE THIS APPLIANCE TO RAIN OR MOISTURE.

CAUTION : TO PREVENT ELECTRIC SHOCK, MATCH BLADE OF PLUG TO WIDE SLOT, FULLY INSERT

ATTENTION : POUR ÉVITER LES CHOCs ÉLECTRIQUES, INTRODUIRE LA LAME LA PLUS LARGE DE LA FICHE DANS LA BORNE CORRESPONDANTE DE LA PRISE ET POUSSER JUSQU'AU FOND

IMPORTANT SAFEGURDS

READ BEFORE OPERATING EQUIPMENT

This product was designed and manufactured to meet strict quality and safety standards. There are, however, some installation and operation precautions which you should be particularly aware of.

1. Read instructions - All the safety and operating instructions should be read before the appliance is operated.
2. Retain instructions - The safety and operating instructions should be retained for future reference.
3. Heed Warnings - All warnings on the appliance and in the operating instructions should be adhered to.
4. Follow Instructions - All operating and use instructions should be followed.
5. Cleaning - Unplug this product from the wall outlet before cleaning. Do not use liquid cleaners or aerosol cleaners. Use a damp cloth for cleaning.
6. Attachments - Do not use attachments not recommended by the product manufacturer as they may cause hazards.
7. Water and Moisture - Do not use this product near water - for example, near a bath tub, wash bowl, kitchen sink, or laundry tub, in a wet basement, or near a swimming pool, and the like.
8. Accessories - Do not place this product on an unstable cart, stand, tripod, bracket, or table. The product may fall, causing serious injury to a child or adult, and serious damage to the appliance. Use only with a cart, stand, tripod, bracket, or table recommended by the manufacturer, or sold with product. Any mounting of the appliance should follow the manufacturer's instructions, and should use a mounting accessory recommended by the manufacturer.
9. Ventilation - Slots and openings in the cabinet are provided for ventilation and to ensure reliable operation of the product and to protect it from overheating, and these openings must not be blocked or covered. The openings should never be blocked by placing the product on a bed, sofa, rug, or other similar surface. This product should never be placed near or over a radiator or heat register. This product should not be placed in a built-in installation such as a bookcase or rack unless proper ventilation is provided or the manufacturer's instructions have been adhered to.
10. Power sources - This product should be operated only from the type of power source indicated on the marking label. If you are not sure of the type of power supply to your home, consult your appliance dealer or local power company.
11. Grounding or Polarization - This product is equipped with a polarized alternating-current line plug (a plug having one blade wider than the other). This plug will fit into the power outlet only one way. This is safety feature. If you are unable to insert the plug fully into the outlet, try reversing the plug. If this should still fail to fit, contact your electrician to replace your obsolete outlet. Do not defeat the safety purpose of the polarized plug.
12. Power-Cord Protection - Power supply cords should be routed so that they are not likely to be walked on or pinched by items placed upon or against them, paying particular attention to cords at plugs, convenience receptacles, and the point where they exit from the appliance.
13. Protective Attachment Plug - The appliance is equipped with an attachment plug having overload protection. This is a safety feature. See Instruction Manual for replacement or resetting of protective device. If replacement of the plug is required, be sure the service technician has used a replacement plug specified by the manufacturer that has the same overload protection as the original plug.
14. Lightning - For added protection for this product during lightning storm, or when it is left unattended and unused for long periods of time, unplug it from the wall outlet. This will prevent damage to the product due to lightning and power-line surges.
15. Overloading - Do not overload wall outlets and extension cords as this can result in a risk of fire or electric shock.
16. Object and Liquid Entry - Never push objects of any kind into this product through openings as they may touch dangerous voltage points or short-out parts that could result in a fire or electric shock. Never spill liquid of any kind on the product.
17. Servicing - Do not attempt to service product yourself as opening or removing covers may expose you to dangerous voltage or other hazards. Refer all servicing to qualified service personnel.
18. Damage Requiring Service - Unplug this product from the wall outlet and refer servicing to qualified service personnel under the following conditions:
 - a. When the power-supply cord or plug is damaged.
 - b. If liquid has been spilled or objects have fallen into the product.
 - c. If the product has been exposed to rain or water.
 - d. If the product does not operate normally by following the operating instructions. Adjust only those controls that are covered by the operating instructions as an improper adjustment of other controls may result in damage and will often require extensive work by a qualified technician to restore the product to its normal operation.
 - e. If the product has been dropped or cabinet has been damaged.
 - f. When the product exhibits a distinct change in performance - this indicates need for service.
19. Replacement Parts - When replacement parts are required, be sure the service technician has used replacement parts specified by the manufacturer or have the same characteristics as the original parts. Unauthorized substitutions may result in fire, electric shock or other hazards.
20. Safety Check - Upon completion of any service or repairs to this product, ask the service technician to perform safety checks to determine that the product is in proper operating condition.
21. Carts and Stands - The appliance should be used only with a cart stand that is recommended by manufacturer.
22. An appliance and cart combination should be moved with care. Quick stops, excessive force, and uneven surfaces may cause the appliance and cart combination to overturn.

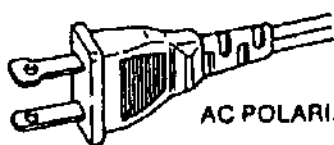

AC POLARIZED PLUG



FRONT PANEL SECTION

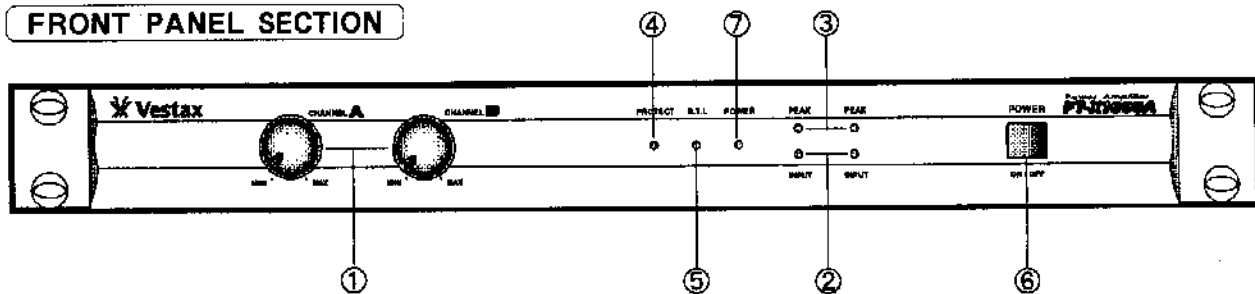

REAR PANEL SECTION

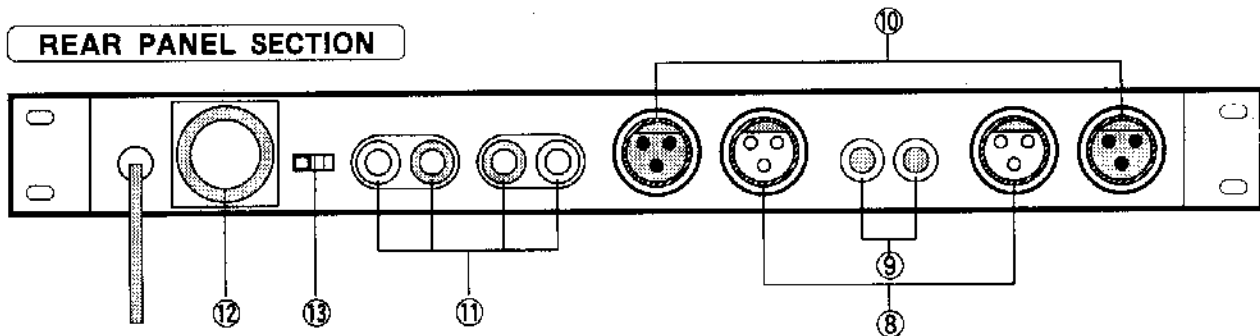

FUNCTIONS

① LEVEL KNOB CH-A, CH-B

a) CH-A: Adjusts output level when the unit is used in Stereo Mode.

Adjusts overall output level when the unit is used in Mono (BTL) Mode.

b) CH-B: Adjusts output level when the unit is used in Stereo Mode.

Ineffective if the unit is used in Mono (BTL) Mode.

② INPUT LED

Flashes at input level over -50dBV

③ PEAK LED

Flashes when output level is reached to the peak level.

④ PROTECT LED

Lights when Protection circuit is in operation. Signal will be cut by relay of the circuit if the following problems have occurred.

a) Unusual rise of the temperature of transformer or heat sink inside.

b) Short circuit of speaker terminal.

c) Excessive input or output.

⑤ BTL LED

Flashes at the unit when used in BTL (MONO) Mode.

⑥ POWER SWITCH

⑦ POWER LED

Lights when power is on.

⑧ XLR INPUT TERMINAL (BALANCE)

PIN 1 Ground, PIN 2 Hot, PIN 3 Cold.

⑨ 6ϕ PHONE PLUG INPUT TERMINAL (UNBALANCE)

Balanced input available by using Stereo plug.

⑩ XLR INPUT LINK TERMINAL (BALANCE)

PIN 1 Ground, PIN 2 Hot, PIN 3 Cold.

⑪ SPEAKER TERMINAL

⑫ COOLING FAN

Starts automatically when the unit is on and cools down the heat sink inside. Do not put anything in front of the fan for best cooling.

⑬ BTL SWITCH

Select Stereo or Mono (BTL) with this switch.

NOTE

1. PT-X1000A is designed for 4Ω speaker. Vestax has no responsibility for damage to speakers which are lower than 4Ω .
2. To prevent damage to the unit, please turn off the power when you plug in or remove the plug from the electric outlet.
3. Please make sure that speaker cables are tightened firmly at the speaker terminal. Also please try to avoid short circuit.

CONNECTION

(1) STEREO

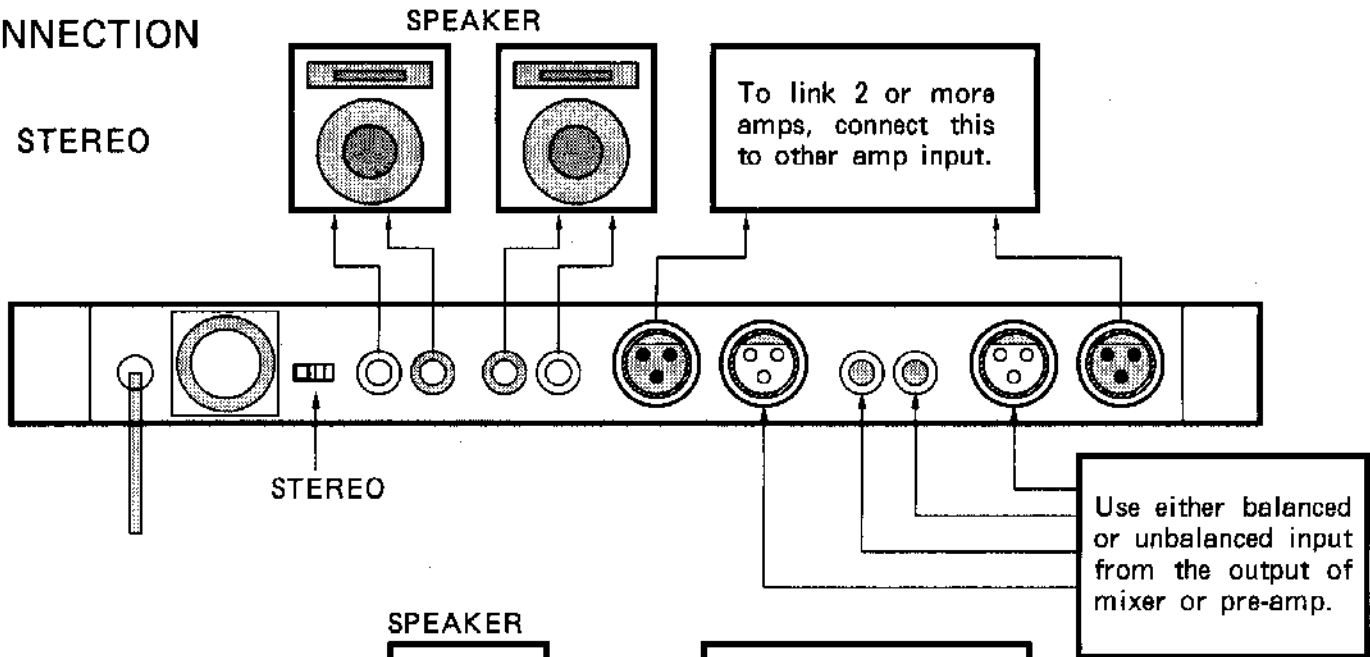

(2) MONO

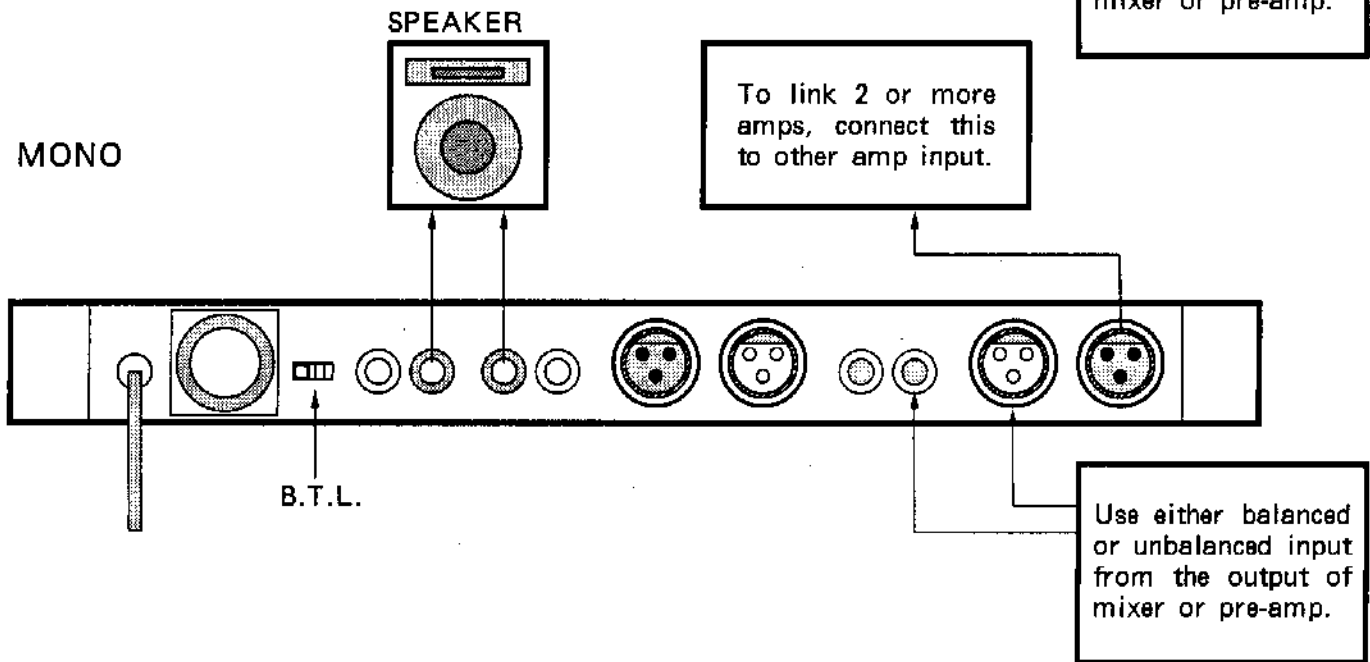

SPECIFICATION

Power Output	: STEREO 90W+ 90W RMS into 8 ohms 130W+130W RMS into 4 ohms
	: MONO 180W RMS into 8 ohms
Input Sensitivity	: 0 dB 775mV (BALANCED)
Input Impedance	: 10K Ω
Frequency Response	: 13 Hz~35kHz +0 dB, -1.5dB
Distortion(THD)	: 0.01%
Slew Rete	: 25V/ μ sec
Damping Factor	: 400 at 1 KHz into 8 ohms
S/N Ratio	: 95 dB
Protection	: DC/Short Circuit
Cooling	: FAN
Dimensions	: 19 inch 1U size, 448 \times 44.5 \times 357(mm)
Weight	: 5 KGS

PT - X1000A

MOUNTING BRACKET ASSEMBLY

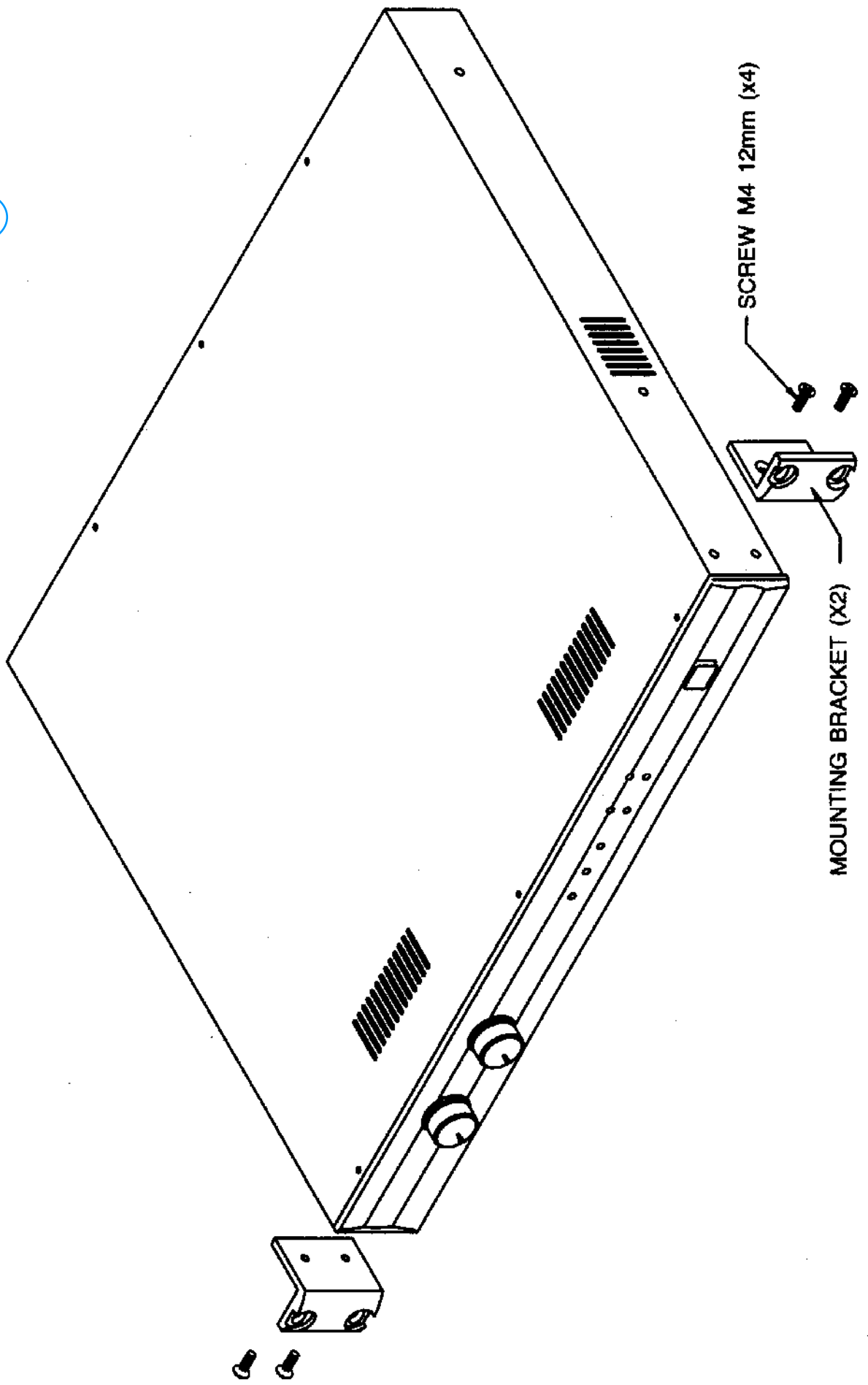
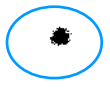

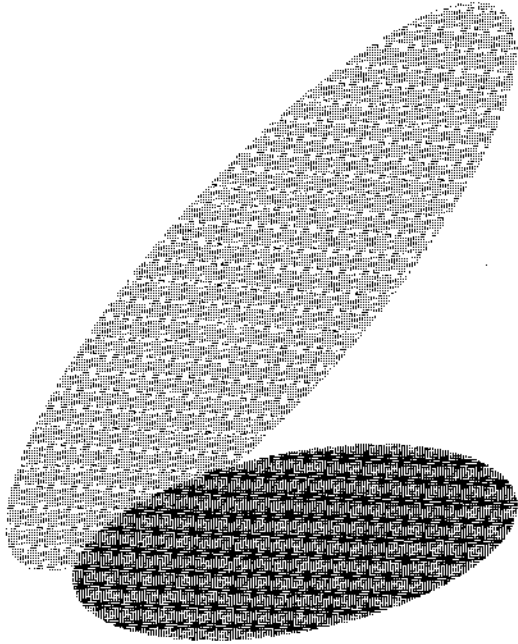

Vestax Corporation